

TOYOTA

CENTURY®



CENTURY®



CENTURY[®]

FIBERGLASS TRUCK CAPS

Crank up your capacity with Century[®] fiberglass truck caps. These premium-grade truck caps are custom-built to match every Toyota model for a sleek look and secure fit. And with tons of options, you can customize your cap to get exactly what you want. From cab-high to high-rise, smooth sides to expansive window design, Century truck caps make no job too big, no adventure too far out of reach.

Century is Veteran-owned and proudly hand-crafted in three U.S. manufacturing and design facilities. Our incredible attention to detail and innovative engineering are what keeps Century at the top of our game.



Proudly Veteran-Owned



Custom Created to
Match Every Truck Model



Limited Lifetime
Warranty[†]

LET NOTHING HOLD YOU BACK.

[†]See complete warranty statement for details.

ACCEPT NOTHING LESS THAN **THE BEST**

Capability, capacity, and convenience. Century has made its mark with its unwavering dedication to quality. From design to materials, construction to every valuable member of our team, Century is made strong to live long.

- Low Resin-Filled Fiberglass for Improved Impact Resistance
- Axalta Automotive Paint for Precise Color Match
- Reinforced Roof
- Tinted, Tempered Automotive Glass Rear Doors and Side Windows
- Heavy-Duty Weather Resistant Seals
- Custom Designed for Every Chevrolet / GMC Truck Model
- Precision Engineering to Fit Your Truck Bed
- Contoured Tailgate Overlay

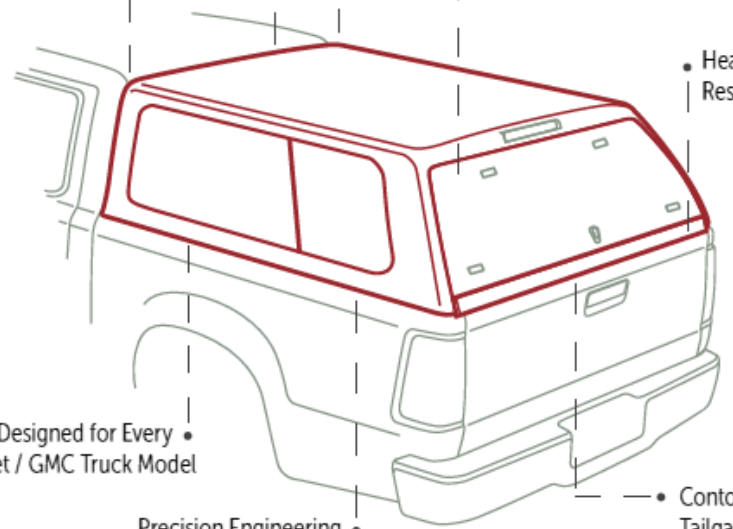

CENTURY CAP HEIGHTS

Capacity = Capability. Century offers three cap heights so you never fall short on any challenge. And with priorities of fuel-efficiency and low road noise, Century not only looks great, but performs to the highest standard.

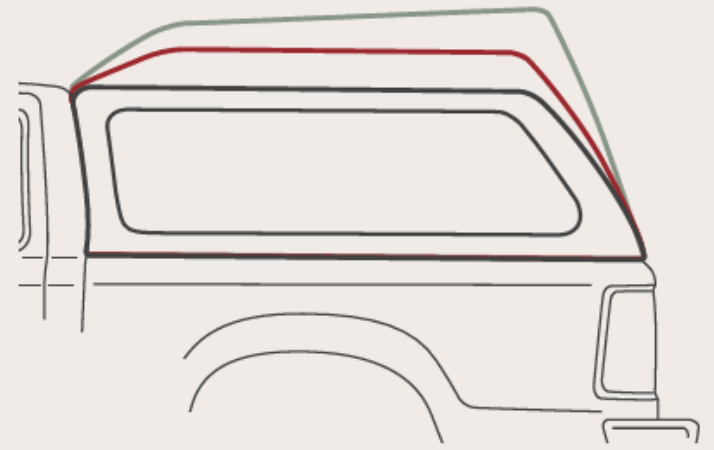

- High-Rise**
up to 40% more storage capacity on T-Class
- Mid-Rise**
up to 15% more storage capacity on High-C Series
- Cab-High**
Consistent height with your truck cab

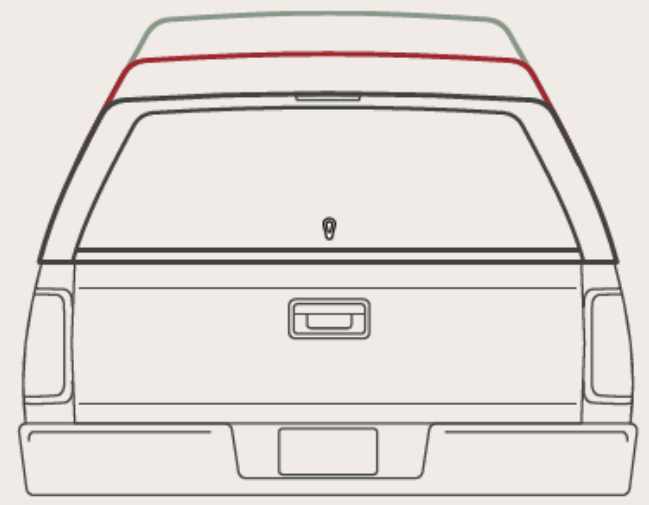



Fixed Front Window

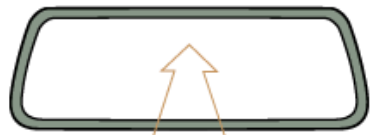

Removable Front Picture Window*

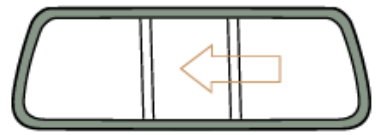

Front Slider Window

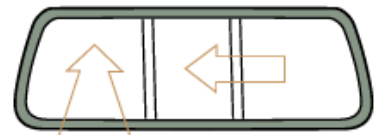

Removable Front Slider Window*

FRONT WINDOWS

WINDOWS

MORE THAN JUST LOOKS

Windows are an important decision. Century windows provide you with multiple options for ventilation for pets, plants, and cargo, as well as easy access to items stored deep within your truck bed.

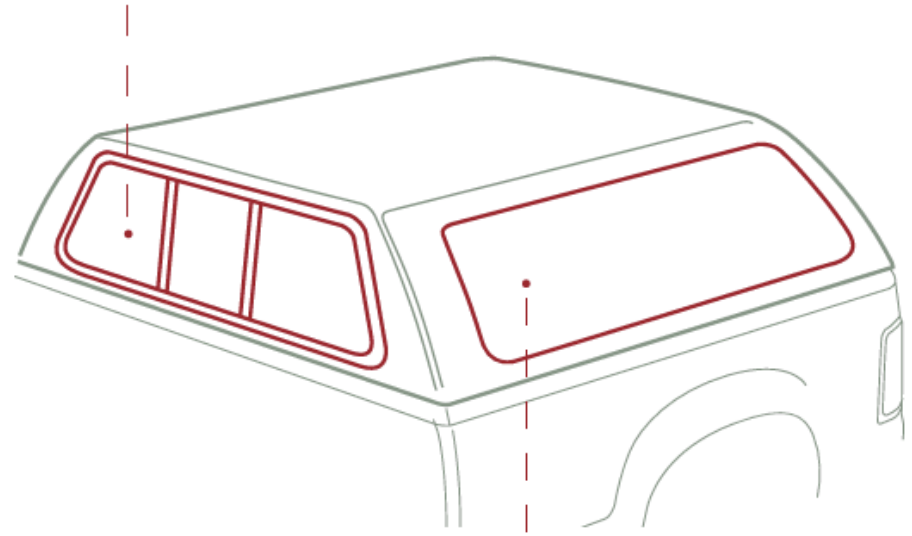

SIDE WINDOWS

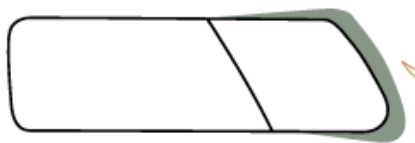

Side Windows w/Twist-Out Vents and Screens



One-Piece Tip-Out Side Windows w/Screen (back part only)

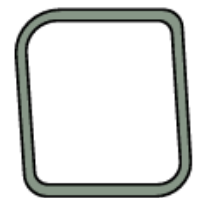

Side Bay Windows



Radius Side Windows

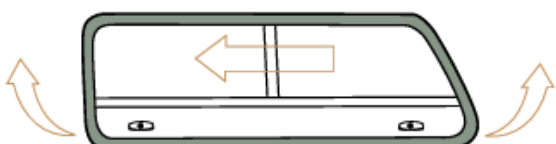

Radius Side Window Sliders

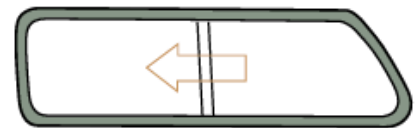

50/50 Sliding Windows w/Screens

*May use a tilt down window vs. a removable window in some regions. Consult your authorized Century dealer in your market.



ROYAL SPORT

UNSURPASSED STYLE

The wait is finally over. Introducing the premium Century Royal Sport. Our ultra-detailed, custom cap complements your truck's design while also adding coveted cargo space and refreshingly convenient, weather-resistant tip-out side windows and door skirt.

- One-Piece Tip Out Side Windows with Removable Screens
- Frameless Curved Glass Rear Door
- Headliner
- Rotary Latch System
- LED Dome Light
- + Keyless Entry (optional)
- + LED Tube Light (optional)
- + 12-Volt Power Block (optional)
- + Cargo Hooks (optional)

STANDARD FEATURES ON ALL MODELS

- One-Piece Fiberglass Base Rails
- Recessed Third Brake Light (LED Red Lens)

- Limited Lifetime Warranty*

ROYAL



GET NOTICED

Century Royal dials up the amenities, security, and design to enjoy more of every mile. Its fluid lines and premium components give the Royal the look of a high-end SUV with the utility and capacity to win at any adventure.

- Recessed Side Windows with Twist-Out Vents and Screens
- Frameless Curved Glass Rear Door
- Rotary Latch System
- + Keyless Entry (optional)

[‡]While vehicle is not in motion or running

ULTRA SPORT



ROOM WITH A VIEW

Century Ultra Sport features an all-glass rear door with a center-mounted teardrop lock for wide-viewing angles, a polished look, and convenient security. Ultra Sport's recessed 50/50 sliding windows provide quick cap ventilation while integrating seamlessly with the overall look of your truck.

- Recessed Tinted Side Sliding Windows and Screens
- Frameless Curved Glass Rear Door
- Rotary Latch System
- + Keyless Entry (optional)
- + Window Slider (optional)
- + Window (optional)

**Standard on all models except for Ultra S †Non-recessed windows

- Tinted Rear Glass Doors
- Fixed Front Window

- Custom Fit for Every Model
- Axalta Automotive Paint

- Insulated Roof
- Gas Door Props

- Installation Bulb Seal**
- J-Bolt Installation Clamps**

- Skirted Rail (Varies by Model)

ULTRA



JUST RIGHT

Step up to Century Ultra with standard 50/50 Slider side windows and double T-handle locks. Perfect for traveling pets, camping, or just adding some fresh air to your sports equipment, plants, pets[†], or any cargo.

- 50/50 Sliding Side Windows
- Dome Light
- + Windoor Slider (optional)
- + Windoor (optional)

[†]While vehicle is not in motion or running

ULTRA S



SMOOTH AS THEY COME

Century Ultra S is a fiberglass-sided truck cap for those who crave added security, wish to apply design graphics, or prefer a solid look to complement their style.

- Smooth Sides
- Double T-Handle Locks
- + 50/50 Slider (optional)[‡]
- + Windoor (optional)[‡]
- + Windoor Slider (optional)[‡]
- Framed Glass Rear Door
- Fixed Front Window
- + J-Bolt Installation (optional)[‡]
- + Installation Bulb Seal (optional)[‡]

** Standard on all models except for Ultra S † Non-recessed windows

HIGH-C



SPACE TO BREATHE

Century truck caps make everything easier to get the job done right. With its high door frame, 50/50 sliding windows, and mid-rise design, Century High-C opens up new opportunities for gear, pets, and oversized cargo like furniture and bulky recreational equipment.

- Double T-Handle Locks
- Recessed Framed Door
- Up to 15% More Interior Room Over Cab-High Models
- Recessed 50/50 Side Sliding Windows with Screens

T-CLASS



GREAT EXPECTATIONS

Leave nothing to question. Century T-Class rises above the norm to deliver on giant cargo demands or even a plush camping space. With up to 52" of interior height, beautiful bay windows, and a tall rear door, T-Class redefines the possibilities of any adventure — work or play.

- Aerodynamic High-Rise Profile
- Up to 40% More Interior Room Over Cab-High Models
- 50/50 Slider and Side Bay Window
- + Full Length 50/50 Slider (optional)[‡]
- + Windoor (optional)[‡]
- + Windoor Slider (optional)[‡]

Limited Availability. Consult your local dealer for details.

[‡] Non-recessed windows

UPGRADES

At Century, we never forget that sometimes the little things make all the difference. From pet screens to hangers, keyless remote locks to 12V powerblocks — Century upgrades help you customize your cap for whatever adventure lies ahead.



SCREEN PROTECTORS



KEYLESS ENTRY
(Using your truck's key fob)



INTERIOR CLOTHES HANGER
(Single or double)

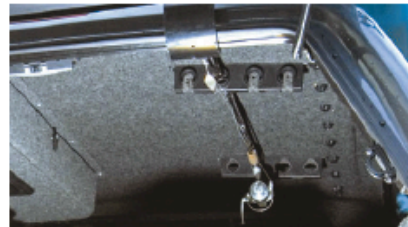

FISHING ROD HOLDER

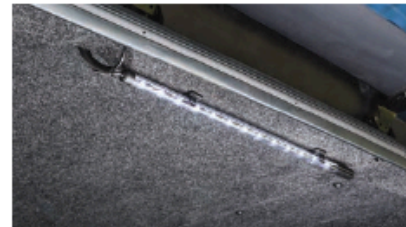

LED TUBE LIGHTING

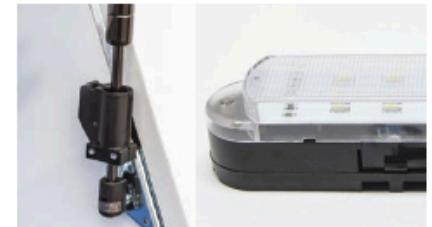

SWITCH ACTIVATED LIGHTING



INTERIOR HEADLINER



THREE-OUTLET 12-VOLT POWERBLOCK



OVERHEAD GEAR NET
(Requires roof rack)



CARGO HOOKS

THULE[®] SWEDEN

Top off your Century truck cap with a wide assortment of Thule roof racks and track systems. It's the finishing touch that helps you pile on the possibilities.



TRACKER II ROOF RACK SYSTEM
(Includes locks)



WING BAR EVO
(Includes locks)



TRACKS ONLY
(Works with most track-mounted crossbars)

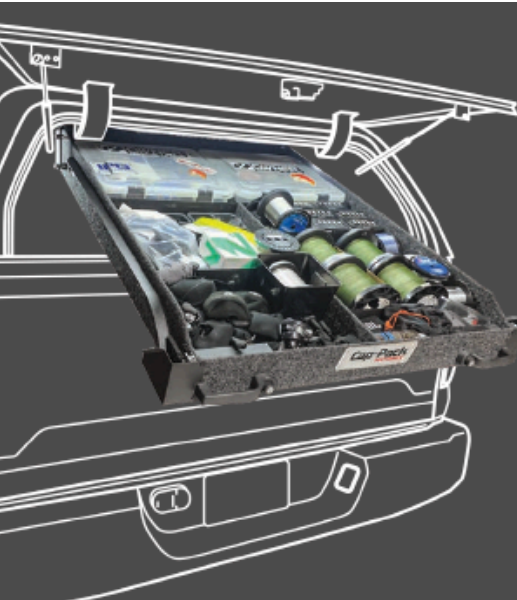

Cap-Pack[®] SPORT

Organization is key. Cap-Pack Sport transforms overhead space into a sliding drawer to make order out of any chaos. Tools, sports equipment, landscaping – you name it.

Cap-Pack Sport is the tried, true, and tested storage solution forged to handle the toughest wear and the most random of requests.

- Cap-Pack Sport not available on T-Class
- May not be available for all trucks/bed sizes. Consult your authorized Century dealer.

BEDSLIDE[®]

Your world is now at your fingertips with BEDSLIDE[®]. This innovative slide system puts everything easily within reach. And with a selection of models with capacities ranging from 1,000 to 2,000 lbs. and options that include multiple bins to organize tools and recreation gear, BEDSLIDE is a proven winner.



COMPARISON CHART	● Standard	+	Option	Royal Sport	Royal	Ultra Sport	Ultra	Ultra S	High-C	T-Class
	Frameless Hidden Hinge Curved Rear Door	●			●	●	●			
Recessed Framed Door w/Double T-Handle Locks							●	●	●	●
Teardrop Twist Lock Handle	●			●	●	●				
Automotive Style Rotary Latches	●			●	●	●				
Interior Headliner	●		+	●	+	+	+	+	+	+
Interior LED Dome Light	●			●	●	●	●	+	●	●
LED Tube Lighting		+		+	+	+	+	+	+	+
Keyless Entry (Using Your Truck's Key Fob)		+		+	+	+				
Additional Battery or 12V Dome Light		+		+	+	+	+	+	+	+
12V Gas Prop Switch for Interior Lighting		+		+	+	+	+	+	+	+
Blank Sides (No windows)						+	+	●	+	+
Screen Protectors			+		+	+	+	+	+	+
Side Windows w/Twist-Out Vents					●					
One-Piece Tip-Out Side Windows	●			●						
50/50 Sliding Windows						●	●	+	●	●
Radius Side Windows						+	+	+	+	+
Radius Side Window Sliders						+	+	+	+	+

Not all options are available for all models and trucks. Century maintains the right to add, delete, or change designs and/or suppliers of options when necessary to maintain or improve the overall quality without written notice.



All illustrations and specifications contained in this literature are based on the latest product information at the time of publication. Check with your local Century Retailer for complete product information. Century reserves the right to make changes in prices, colors, materials, equipment, specifications, and models at any time without notice or prior obligation. ©2023 Century[®], Leer Group LLC; A J.B. Poindexter Company. Form #TAGLIT22 | Rev 7/23

⚠ CALIFORNIA PROPOSITION 65 WARNING ⚠

WARNING: This product contains chemicals known to the State of California to cause cancer and birth defects or other reproductive harm.
For more information: www.P65Warnings.ca.gov

* See complete warranty statement at www.centurycaps.com for details.



AUTHORIZED CENTURY RETAILER



Est. 1966

