

COMMERCIAL PRODUCTS



WHY BUY A.R.E.?



UNMATCHED SERVICE:

Industry leading support from over 700 dealers & partners throughout the US and Canada.



BUY WITH CONFIDENCE:

Limited lifetime warranty on all fiberglass caps and covers.



MADE IN THE USA:

Every order is custom built right here in the US.



INNOVATION LEADERS:

Our focus is to live outside the industry norm – designing and developing the most advanced products.



ISO CERTIFIED:

We are the first and only ISO certified truck cap and cover manufacturer in the US.



OUTFIT TO LAST

For over 50 years we have been covering truck beds with the most innovative, highest quality caps and covers built in the heartland of America: Northeast Ohio. We know you love your truck, which is why our passion is to manufacture the perfect companion for your truck, backed by the industry's best support and warranty. Take a look around, we believe you'll see exactly what you need to outfit your truck for life.

COMMERCIAL ALUMINUM	4
HD	11
TOOLMASTER	14
FUSION	18
3DL	20
LSII	21
ADDITIONAL ACCESSORIES	22



GET TO WORK WITH A COMMERCIAL ALUMINUM CAP



THE RIGHT TOOL FOR YOUR TRUCK

A.R.E.'s rugged welded frame construction offers years of durable service, no matter what the weather or job. Each unit has weather-sealed doors with gas props, heavy-duty hinges, and automotive-style locks to protect your valuables.



DCU MAX™



DCU
DIAMOND EDITION™

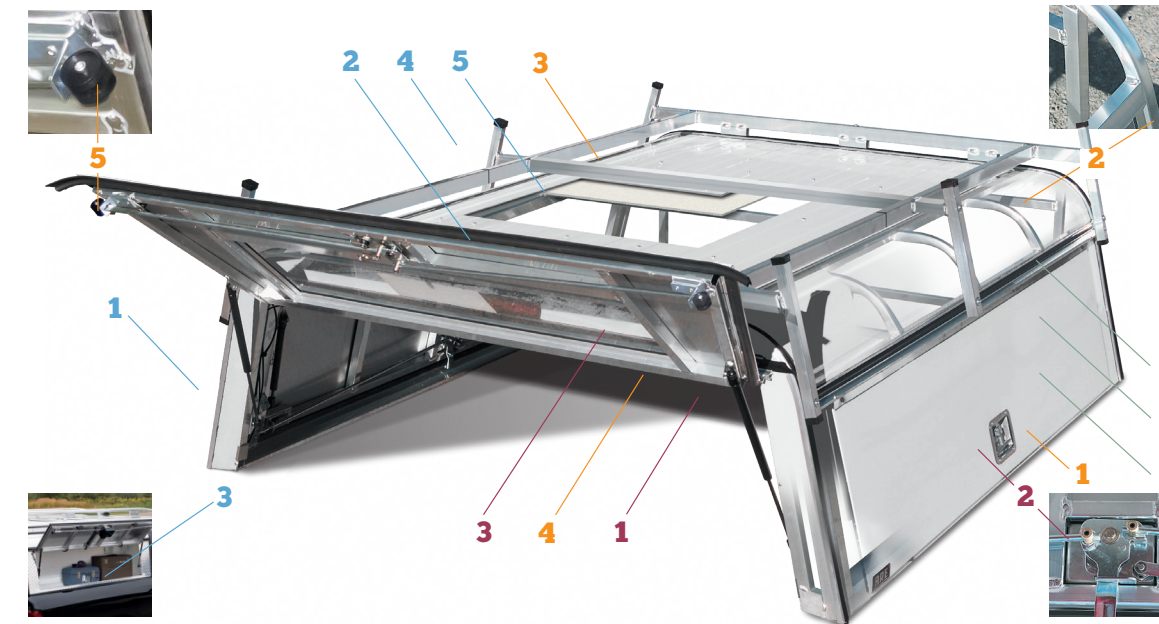

OPTIONS

- 1 Height** – A.R.E. has four standard heights plus three wedge heights to meet your specific capacity needs. (Height and wedge availability varies by model.)
- 2 Rear Doors** – A.R.E. offers many door styles for your rear access needs.
- 3 Side Toolboxes** – Toolboxes are made of .036 galvanized steel with a baked white coat or .063 diamond plate, depending on model. The bins can be customized to include dividers and fold-down shelves.
- 4 Roof Racks** – A.R.E. offers many different racks to meet your specific hauling needs. Extra cross bar supports are available.
- 5 Vapor Barrier Insulation** – Optional dark gray headliner provides protection from condensation.

STRUCTURE

- 1 Baserails** – 0.80" thick T6 aluminum baserails with MIG welded corners provide a strong foundation.
- 2 Structural Tubing** – .050" thick T6 aluminum tubing framework with TIG welded joints provides strength and support with minimal weight.
- 3 Exterior Skin** – .035" (DCU®), .063" (DCU MAX™) or .063" diamond plate (Diamond Edition DCU™) thick aluminum exterior skin for superior structure.
- 4 Door Frames** – A.R.E. builds all styles of doors with the same .050" thick wall tubing used in the body frame. All TIG welded joints and continuous hinges assure alignment and durability.
- 5 Roller Rods** – One-hand operation to provide easy access and improved seal.

FINISH

- 1 Body Colors** – A.R.E. offers our DCU® in white, dove gray or black and our DCU MAX™ in white. The color is baked enamel finish applied to the aluminum skin at the mill. The color is not meant to provide a match to any OEM truck paint, but is intended to accent the truck's appearance without the cost of custom painting.
- 2 Custom Axalta® Paint Finishes** – Optional two-stage ChromaPremier® paint is offered in any OEM or fleet color code formula. Applied in our downdraft booths and baked on for durability.
- 3 Trims** – Edge trims are offered in black or white.

COMPONENTS

- 1 Gas Props** – Our gas props are set to the optimal pressure to assist in lifting and closing each cap door.
- 2 Latches and Locks** – The folding T-grip latch handle is durable and offers top security. The cam action deadbolt lock rods with the center point lock provide lifelong trouble-free operation. All latches and locks have 500 hours non-corrosion finish.
- 3 Windows** – A.R.E. offers radius dark tinted tempered safety glass in all doors. Optional heavy aluminum mesh security screens deter unwanted entry.

BUILD YOUR PERFECT ALUMINUM CAP

Follow these 12 steps and check options clearly. Consult your local A.R.E. dealer for more details or with questions regarding any of the options shown here.

1 CHOOSE YOUR MODEL



DCU (.035")

- Strength and durability for everyday use
- Heavy-duty .035" aluminum skin
- Standard 1/2 rear door
- Standard full length side door
- Available in wedge style
- Galvanized steel toolboxes with baked white coating



DCU MAX (.063")

- Increased strength and durability for the toughest work environments
- Heavy-duty .063" aluminum skin
- Stainless steel strap hinges on double or single full doors
- Galvanized steel toolboxes with baked white coating



DE Diamond Edition DCU (.063" Diamond Plate)

- Increased strength and durability for the toughest work environments with added style
- Heavy-duty .063" diamond plate aluminum skin
- Stainless steel strap hinges on double or single full doors
- Diamond plate toolboxes

2 CHOOSE A CAP HEIGHT

A. Select the appropriate height for your needs. Consider headroom, accessibility and the amount of overall space you need.

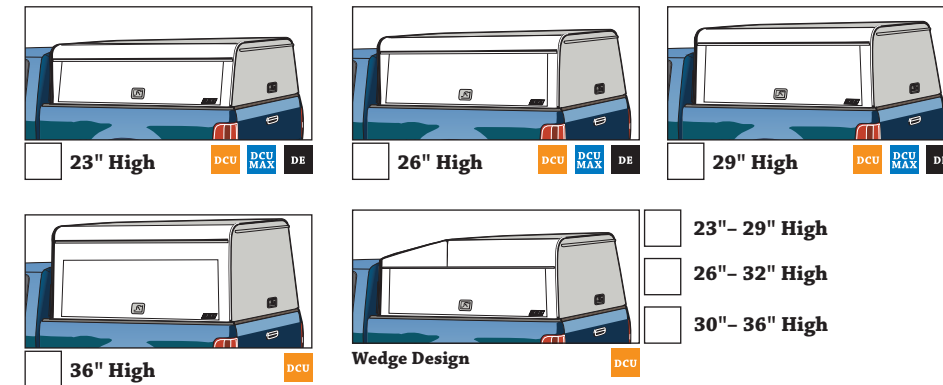

3 CHOOSE A COLOR AND INTERIOR OPTIONS

A. Choose from one of our standard colors or have your cap painted to match the truck manufacturer's paint code.



B. Choose from our interior upgrade options based on your needs for added security, strength or insulation.

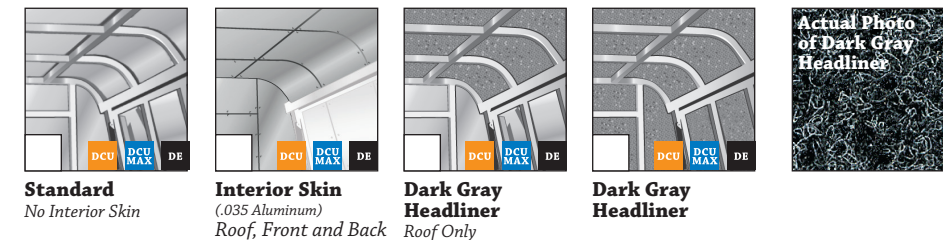

C. Choose a roof vent for increased air circulation.

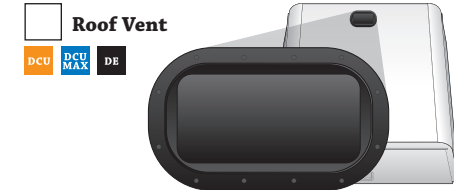

4 CHOOSE A REAR DOOR

A. Choose the rear door and window option that provides optimal accessibility on a daily basis.

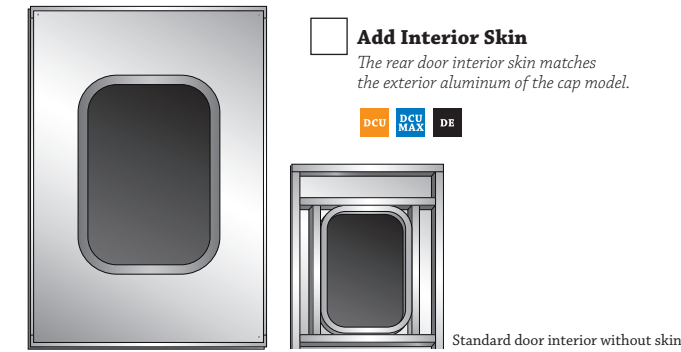
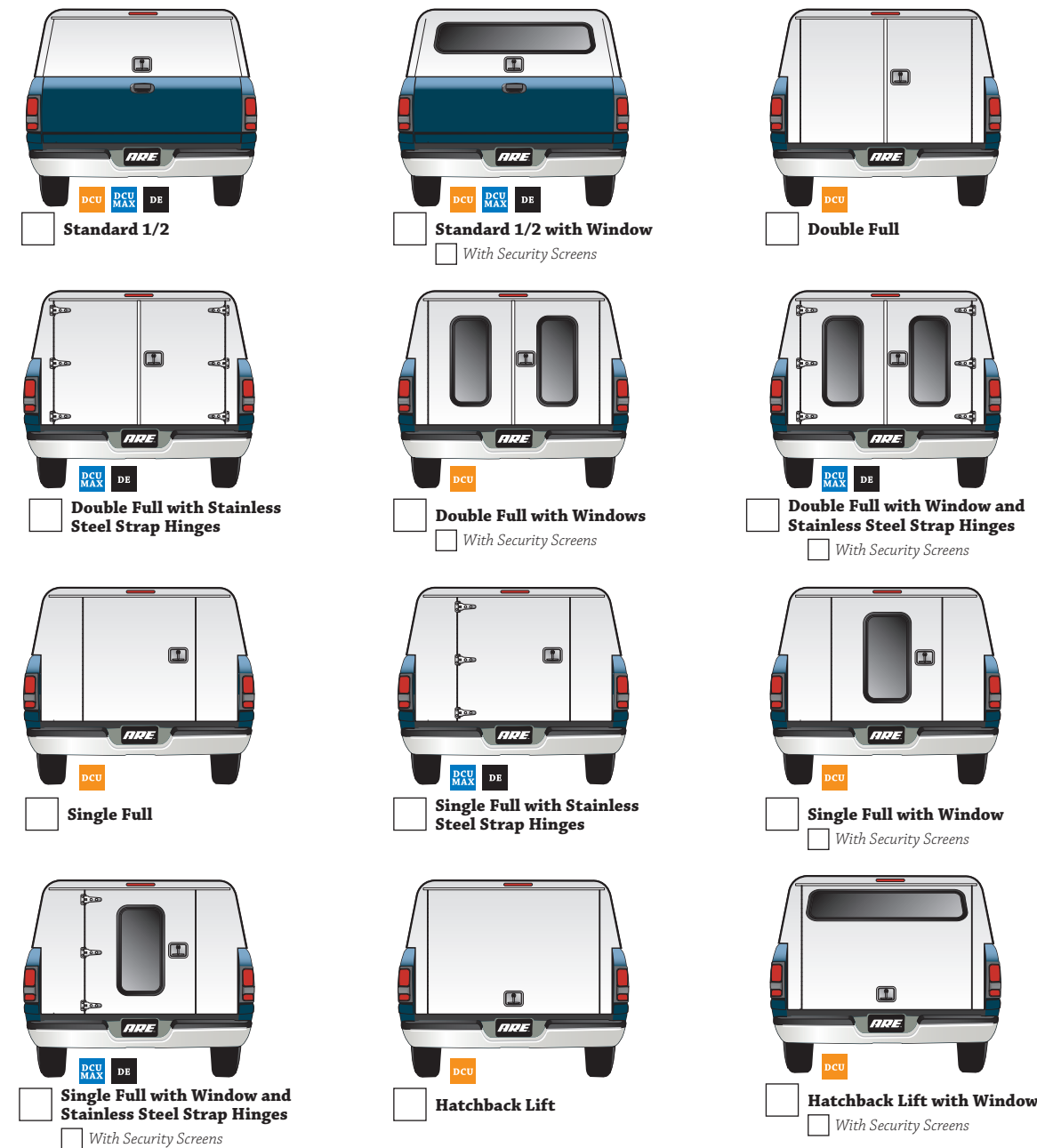

5 CHOOSE A FRONT WINDOW OPTION

A. Choose the front window option based on your security, access and visibility needs.

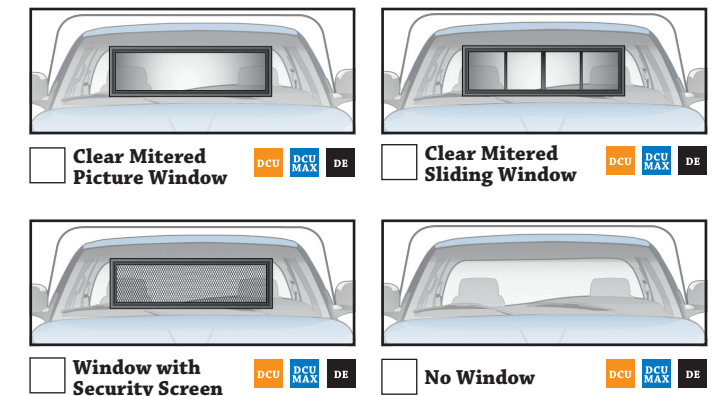

6 KEYLESS ENTRY

A. Utilize your truck's key fob to lock/unlock the cap.



7 CHOOSE A SIDE OPTION

A. Choose the side option that fits your needs for access and visibility. If no selection, sides will be solid.

Standard Full Length

Double Doors

Radius Slider

Full Length with Window
 With Security Screens

Solid Glass Window

Two Windows Only

Interior Skin
 Interior skin matches the exterior skin of the cap

DCU DELUXE COMMERCIAL UNIT[®]

DCU MAX™

8 CHOOSE A TOOLBOX AND SHELVING OPTIONS

Toolboxes and Shelving Options apply to all Commercial Aluminum Models

A. Choose an easy access opening, standard toolbox, or one of the special bin storage packages from Ranger Design. DCU[®] and the DCU Max[™] have steel interiors, the Diamond Edition has diamond plate. Note: Dark gray headliner is not available on toolbox interior

No Toolbox
 Driver Passenger

Standard Toolbox
 Driver Passenger

Contractor Package
 (for both 6'6" and 8' boxes)
 Driver Passenger

Plumber Package
 (for both 6'6" and 8' boxes)
 Driver Passenger

B. Choose one of the 15 toolbox options shown below, a fold-down shelf for use on the job or choose to have no shelves at all.

1 **2** **3** **4** **1 Fold-Down Half Shelf Front**

5 **6** **7** **8** **2 Fold-Down Half Shelf Rear**

9 **10** **11** **12** **3 Fold-Down Full Shelf**

13 **14** **15** **16** **Customized Options Available**

Fold-Down Shelving Options
 Driver Side _____
 Passenger Side _____

9 CHOOSE A LADDER RACK OPTION

Ladder Rack Options apply to all Commercial Aluminum Models

A. Choose an A.R.E. manufactured welded aluminum ladder rack or a commercial-grade aluminum or steel locking ladder rack.

No Ladder Rack

Ladder Rack
 With center support and third leg

Ladder Rack
 With two center supports and third leg

KARGO MASTER
 Heavy-Duty Rack System

JET RACK™
 Interior Ladder Rack System

PRIME DESIGN®

ErgoRack®

Double Clamping

Driver Side Clamp and Passenger Side Rotational

Double Rotational

Optional Step Ladder Adaptor
 Only available for Prime Design models on 8 foot beds.

AluRack®

80" AluRack[®] Aluminum Rack System

98" AluRack[®] Aluminum Rack System

120" AluRack[®] Aluminum Rack System

Easy-Loading Roller System
 Allows ergonomic loading and unloading of ladders, reducing stress and injuries. One person can easily load the ladders without damaging the vehicle.

AluRack® Optional Add-On:
 Quick Clamp Ladder Lock Attachment
 Driver Passenger

10 INCREASE VISIBILITY AND SAFETY

Lighting options apply to all Commercial Aluminum Models

A. Consider where you need light for night visibility, also if you would like the lighting to come on automatically when opening the doors.

Driver's Side Rival Encased LED Lighting Options

Single Door Rope Light

Double Doors Rope Lights

Single Door Rope Light and Auxiliary Rope Light

Double Doors Rope Lights and Auxiliary Rope Lights

Single Door Rope Light and Auxiliary Light

Double Doors Rope Lights and Auxiliary Lights

No Driver Side Rope Light

Prop Switch at Driver Side Will not operate Auxiliary Lights

Passenger's Side Rival Encased LED Lighting Options

Single Door Rope Light

Double Doors Rope Lights

Single Door Rope Light and Auxiliary Rope Light

Double Doors Rope Lights and Auxiliary Rope Lights

Single Door Rope Light and Auxiliary Light

Double Doors Rope Lights and Auxiliary Lights

No Passenger Side Rope Light

Prop Switch at Passenger Side Will not operate Auxiliary Lights

B. Consider adding strobe and / or beacon style lighting for increased visibility and safety

Beacon and Strobe Safety Lighting Options

Beacon Light

Two Beacons

One Beacon (Rear)

One Beacon (Front)

Slim Strobe Light
 Now available in these colors: white/amber, blue, green, red, amber.

Six Slim Strobes

Six Slim Strobes & Front Beacon

Six Slim Strobes & Rear Beacon

Six Slim Strobes & Two Beacons

No Rear Rope Light

Prop Switch at Rear Will not operate Auxiliary Lights

11 INCREASE VISIBILITY AND SAFETY WITH OUR BACK-UP CAMERA OPTION

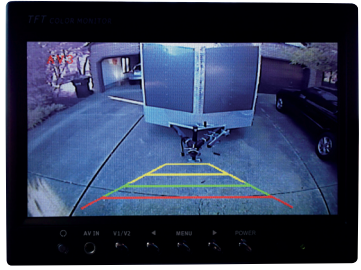

Add back-up camera option

12 CHOOSE REAR DOOR SECURITY OPTION

A. By safely securing your vehicle with Slick Locks puck locks in combination with their patented Spinner 360™ and Weather Shield™, you will be fully equipped with the most preferred vehicle locking system on the market today!



Slick Locks

NOTE: For double full rear doors only



COMMERCIAL ALUMINUM CAP WARRANTY



A.R.E. warrants to the original purchaser of Commercial Aluminum truck caps that they are free from defects in structure, materials and workmanship for a period of three years from the date of purchase from an authorized A.R.E. dealership. See the dealership for a copy of the full warranty statement.

200+ POSSIBLE CAP OPTIONS



With 200 or more variations to choose from, you can create the perfect cap to fit your work needs. Our rugged, fully welded frame construction offers years of durable service, no matter what the weather or job. There's a reason that the A.R.E. DCU Series® is the only truck cap that received a 10 out of 10 rating by Handyman Magazine readers.

Commercial Aluminum Options List ✓ = Standard Features • = Optional Features	DCU (.035" Thick)	DCU MAX (.063" Thick)	DIAMOND EDITION (.063" Thick)
Standard Metal Skin Colors	White, Dove Gray or Black	White	N/A
Paint-to-match	•	•	N/A
Black or White Trim	✓	✓	✓
Height	23", 26", 29", 36"	23", 26", 29"	23", 26", 29"
Wedge Height	23"-29", 26"-32", 30"-36"	N/A	N/A
Slanted Sides/Slanted Front	✓	✓	✓
Radius Front/90° Side Walls on 29" and 36" units only	•	N/A	N/A
Dark Gray Headliner	•	•	•
Metal Inner Skin	•	•	•
Double Full Doors	•	•	•
Single Full Door	•	•	•
Full Hatchback Lift Door	•	N/A	N/A
Radius Slider Windows	•	N/A	N/A
Solid Glass Window	•	N/A	N/A
Sliding Front Window	•	•	•
Solid Front Window	•	•	•
Roof Vent	•	•	•
Slick Lock	•	•	•
Security Screens	•	•	•
Full Length Side Door	✓	✓	✓
Double Side Door	•	•	•
Tool Bins	•	•	•
Dividers in Tool Bins	•	•	•
Fold-Down Shelves	•	•	•
Brake Light	✓	✓	✓
12V LED Interior Lights	•	•	•
Auto Light Switch on Doors	•	•	•
Aluminum Ladder Rack	•	•	•
Prime Design Ladder Rack	•	•	•
KargoMaster Ladder Rack	•	•	•
AluRack® with Easy Loading Roller	•	•	•
CargoGlide® Cargo Access System	•	•	•
TruckVault® Sliding Drawers	•	•	•
Keyless Entry	•	•	•
Back-Up Camera	•	•	•



CONTRACTOR-GRADE DURABILITY

There has never been a stronger and more durable fiberglass truck cap than the A.R.E. HD™. Available for our CX and MX cap profiles, the HD™ features a patented internal skeleton which triples the weight capacity of the roof rack and side toolboxes. If you test the limits of your truck, and need your cap to be up for the challenge, the A.R.E. HD™ truck cap is the only choice!

OPTIONS

- 1 Available for our CX or MX cap profiles
- 2 Rear Doors – Aluminum paneled door with folding T-handles.
- 3 Side Toolboxes – Diamond plate toolboxes depth 12"–16" depending on truck model (200 lb weight rating per box).
- 4 Roof Racks – 5 different racks to meet your specific hauling needs. The HD series rack is the only rack with a 550 lb. weight rating.

STRUCTURE

- 1 Sandable Primer Gelcoat
- 2 Unique Polyester Resin Fiberglass Laminate
- 3 Low Filled Resin Fiberglass – Resin fiberglass provides a superior structure.

FINISH

- 1 Body Colors – A.R.E. offers our HD cap in any color to match your truck body.
- 2 Clear Coat Exterior – Lasting paint protection.
- 3 Automotive Grade Paint – Two-stage ChromaPremier® paint is offered in any OEM or fleet color code formula.

STRENGTH

- 1 Reinforced Roof
- 2 Extra Reinforcement
- 3 Patented Standard Internal Aluminum Skeleton – completely unique to the cap industry



BUILD THE CAP

That is Perfect for Your Needs

Follow these 8 steps and check options clearly. **X**

Consult your local A.R.E. dealer for more details or with questions regarding any of the options shown here.

1 CHOOSE A CAP PROFILE

A. Choose the appropriate cap profile for your needs.

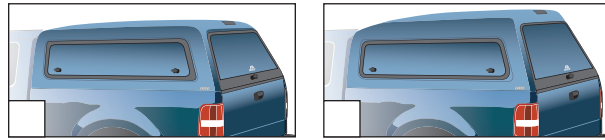

CX **MX**

3 CHOOSE A FRONT WINDOW OPTION

A. Choose the front window option based on your access and visibility needs.

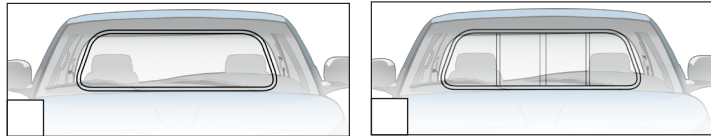

Aluminum Framed Picture Window **Aluminum Framed Sliding Window**

5 CHOOSE A SIDE WINDOW OPTION

A. Choose the side option that fits your needs for access and visibility.

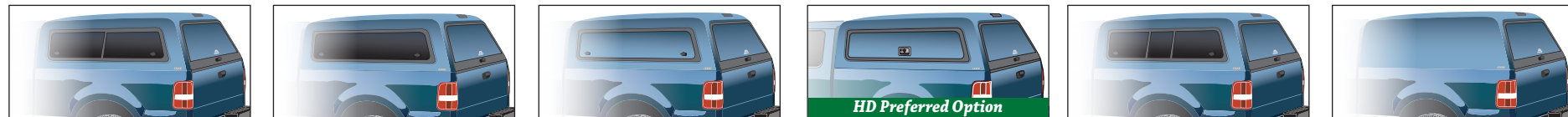

Aluminum Framed Half Slider Driver Passenger
Glass Windoor Driver Passenger
Aluminum Paneled Windoor Driver Passenger
Aluminum Paneled Windoor with Folding T Driver Passenger
Outdoorsman Vented Windoor Driver Passenger
Solid Side Fiberglass Driver Passenger

2 CHOOSE AN INTERIOR FINISH

A. Choose your preference of our two interior options.

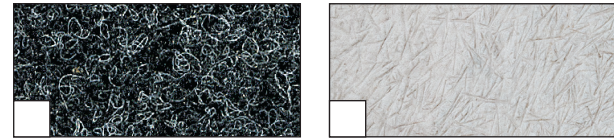

Dark Gray Headliner **Fiberglass Finish**

4 CHOOSE A REAR DOOR

A. Choose the rear door and window option that provides the optimal accessibility on a daily basis.

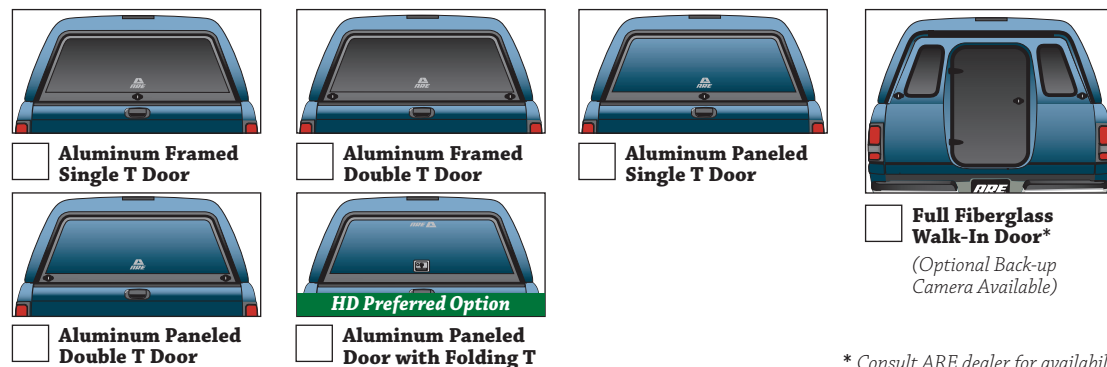

Aluminum Framed Single T Door
 Aluminum Framed Double T Door
 Aluminum Paneled Single T Door
 Aluminum Paneled Double T Door
 Aluminum Paneled Door with Folding T
 Full Fiberglass Walk-In Door*
(Optional Back-up Camera Available)

* Consult ARE dealer for availability

6 CHOOSE TOOLBOX AND SHELVING OPTIONS

A. Choose to have either diamond plate toolbox options or no toolboxes for open bed access. **Note:** Toolbox options available with window options only.

No Toolbox
 Driver Passenger

Standard Toolbox
 Driver Passenger

1 Driver Passenger

HOLDS UP TO 200#



B. Choose the insert option shown below or choose to have no shelves at all.

Driver Passenger

7 CHOOSE A LADDER RACK OPTION

A. Choose a ladder rack that is perfect for your storage needs. **Note:** Only our HD ladder rack receives the 550lb weight rating.

No Ladder Rack

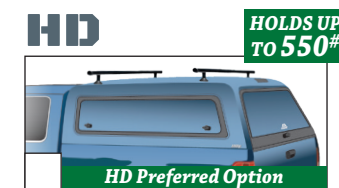

HD Ladder Rack



Universal Mounting Tracks



Yakima CoreBar Roof Rack (Steel)

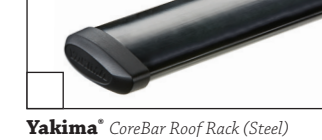

Yakima JetStream Roof Rack (Aluminum)



AluRack Optional Add-On: Quick Clamp Ladder Lock Attachment

PRIME DESIGN

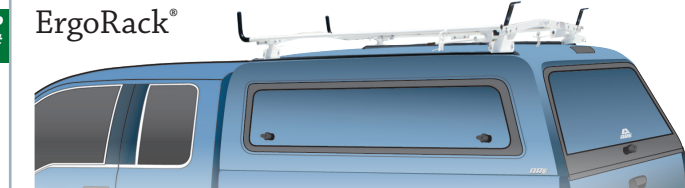

ErgoRack
 Double Clamping **Double Rotational** **Driver Side Clamp and Passenger Side Rotational**

Optional Step Ladder Adaptor
Only available for Prime Design models on 8 foot beds.

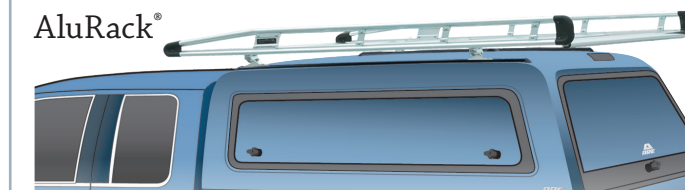

AluRack
 80" AluRack Aluminum Rack System **98" AluRack** Aluminum Rack System **120" AluRack** Aluminum Rack System



AluRack Optional Add-On: Quick Clamp Ladder Lock Attachment

Driver Passenger



Easy-Loading Roller System
 Allows ergonomic loading and unloading of ladders, reducing stress and injuries. One person can easily load the ladders without damaging the vehicle.

8 CHOOSE A RIVAL LED LIGHTING OPTION

A. Choose your preference of our interior lighting options, including our encased rope lights.

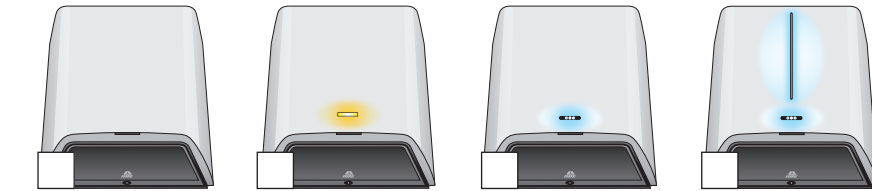

No Interior Lighting
Battery Dome Light With Prop Switch
12V LED Dome Light With Prop Switch
12V LED Dome Light & Center Rope Light With Prop Switch

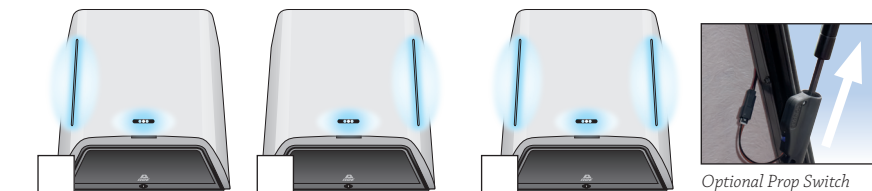

12V LED Dome Light, Driver Side Rope Light With Prop Switch
12V LED Dome Light, Passenger Side Rope Light With Prop Switch
12V LED Dome Light & Dual Rope Lights With Prop Switch

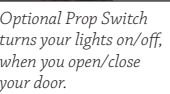

Optional Prop Switch turns your lights on/off, when you open/close your door.

HD WARRANTY

A.R.E. warrants to you, the original retail purchaser of an A.R.E. HD™, that the body will be structurally free from defects in material and workmanship for as long as you own your cap and the original vehicle. The body includes the fiberglass shell and mounting rails only. A.R.E. warrants to you, the original purchaser, for as long as you own your cap that the exterior paint will not abnormally fade or peel due to material or workmanship defect faster than the original pickup it was installed on by an authorized A.R.E. retail dealer.

The internal skeleton frame will be warranted for three (3) years from your retail date of purchase against failure due to defects in material and workmanship.

All other hardware will be covered under standard A.R.E. fiberglass truck cap warranties.

The A.R.E. HD™ has been designed to carry 550 lbs evenly distributed on the HD™ roof rack and 200 lbs evenly distributed in each toolbox.

CAUTION: The weight of this product and the weight of the cargo it was designed to carry may be more than your truck was designed to carry on the bed rails. Please consult your truck manufacturer.

WARNING: The use of this product may raise your vehicle's center of gravity, especially when loaded. Higher center of gravity is known to increase the chance of vehicle rollover.

TRUST THE LEADER

When you purchase our cap for your truck, you have 700 A.R.E. partners across North America ready to serve you. Major leasing companies rely on A.R.E. to provide caps and service to thousands of vehicles they own nationwide. You deserve the same peace of mind that they enjoy. See your local authorized A.R.E. dealer today to order the work cap that meets your needs.



FIBERGLASS CONTRACTOR PACKAGES

ToolMaster™

CONTRACTOR-GRADE DURABILITY

For years, A.R.E. has manufactured high-quality fiberglass caps and tonneau covers as well as rugged aluminum units for commercial use. With our Contractor packages, you can have the appearance and style benefits of our fiberglass caps and tonneau covers with the security and functionality of our commercial units.



ToolMaster™
MX



ToolMaster™
CX

CONTRACTOR-GRADE DURABILITY. FIBERGLASS STYLING.

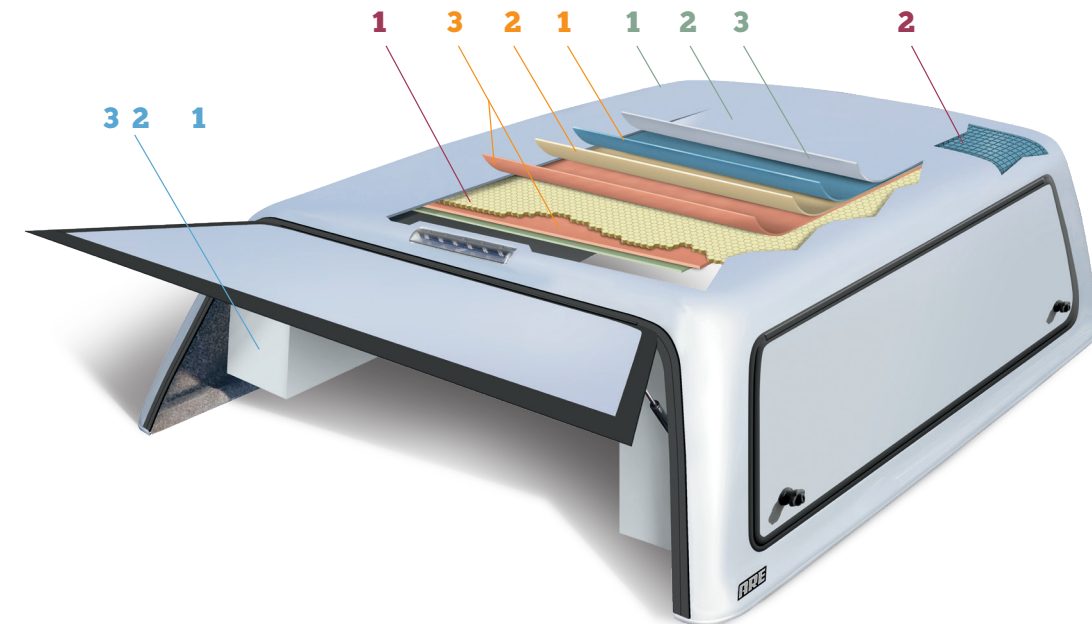

OPTIONS

- 1 3 Models V, CX or MX
- 2 Rear Doors – Aluminum security insert.
- 3 Side Toolboxes – 2 steel toolboxes (1 per side) and weight capacity of 120 lbs. per box.
- 4 Roof Racks – 5 different racks to meet your specific hauling needs.

STRUCTURE

- 1 Sandable Primer Gelcoat
- 2 Unique Polyester Resin Fiberglass Laminate
- 3 Low Filled Resin Fiberglass – Resin fiberglass provides a superior structure.

FINISH

- 1 Body Colors – A.R.E. offers our ToolMaster™ cap in any color to match your truck body.
- 2 Clear Coat Exterior – Lasting paint protection.
- 3 Automotive Grade Paint – Two-stage ChromaPremier® paint is offered in any OEM or fleet color code formula.

STRENGTH

- 1 Reinforced Roof
- 2 Extra Reinforcement



AluRack® commercial roof rack



Toolboxes are engineered for maximum space capacity



Toolboxes are securely fastened to roof framework

Consult your local A.R.E. dealer for more details or with questions regarding any of the options shown here.

1 CHOOSE A CAP PROFILE

A. Choose the appropriate cap profile for your needs.

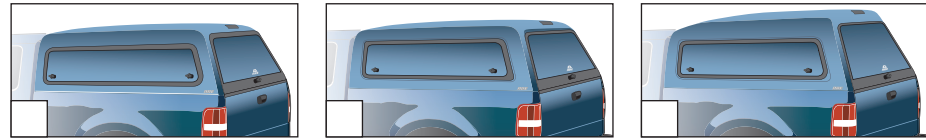

V CX MX

3 CHOOSE A FRONT WINDOW OPTION

A. Choose the front window option based on your access and visibility needs.

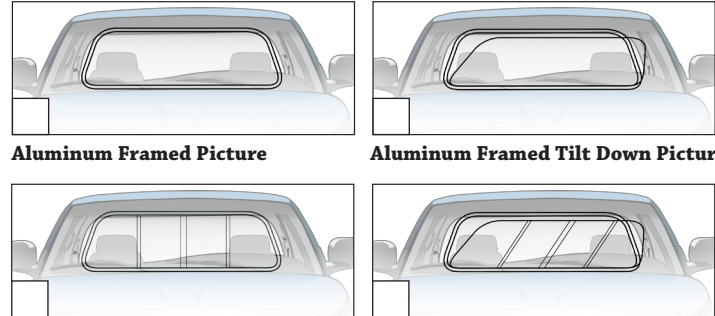

Aluminum Framed Picture Aluminum Framed Tilt Down Picture
Aluminum Framed Sliding Aluminum Framed Tilt-Down Sliding

5 CHOOSE A SIDE WINDOW OPTION

A. Choose the side option that fits your needs for access and visibility.

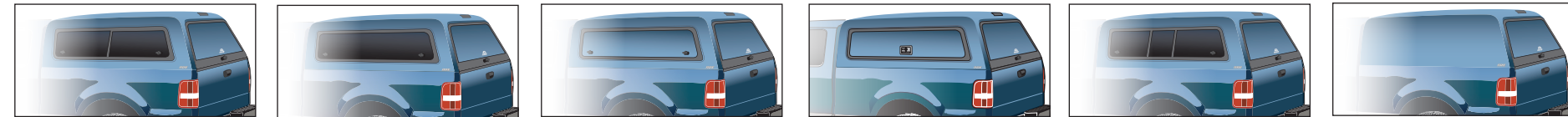

Aluminum Framed Half Slider Glass Windoor Aluminum Paneled Windoor Aluminum Paneled Windoor w/ Folding T Outdoorsman Vented Windoor Solid Side Fiberglass
 Driver Passenger Driver Passenger Driver Passenger Driver Passenger Driver Passenger Driver Passenger

2 CHOOSE AN INTERIOR FINISH

A. Choose your preference of our two interior options.

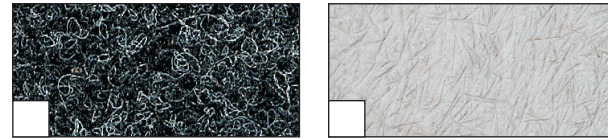

Dark Gray Headliner Fiberglass Interior

4 CHOOSE A REAR DOOR

A. Choose the rear door and window option that provides the optimal accessibility on a daily basis.

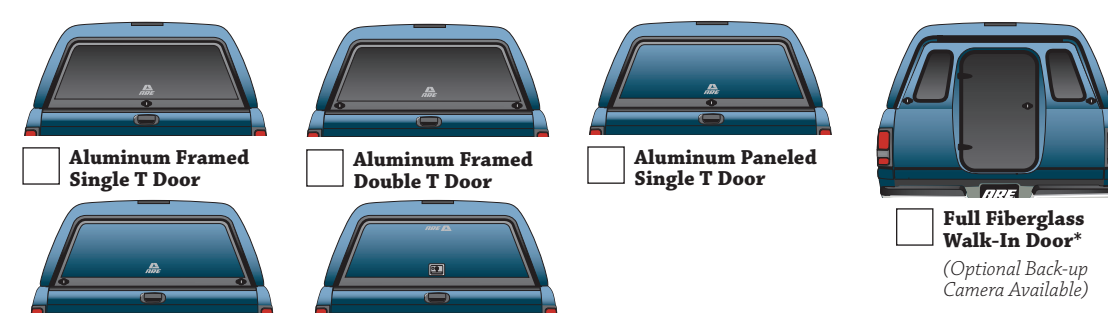

Aluminum Framed Single T Door Aluminum Framed Double T Door Aluminum Paneled Single T Door
Aluminum Framed Double T Door Aluminum Paneled Door w/ Folding T
 Full Fiberglass Walk-In Door*
(Optional Back-up Camera Available)

* Consult ARE dealer for availability

6 CHOOSE A TOOLBOX AND SHELVING OPTIONS

A. Choose to have either toolbox options or no toolboxes for open bed access. **Note:** Toolbox options available with windoor options only.

No Toolbox Driver Passenger **Standard Toolbox** Driver Passenger

B. Choose the insert option shown below or choose to have no shelves at all.

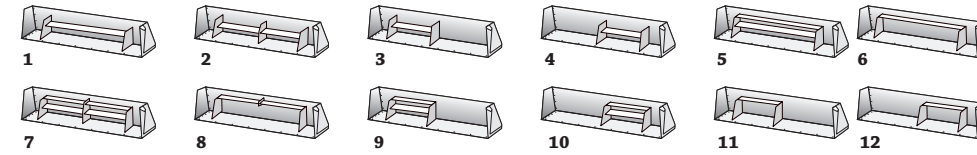

Toolbox Shelving Options Driver Side _____ Passenger Side _____ Akro Bins

7 CHOOSE A LADDER RACK OPTION

A. Choose a ladder rack that is perfect for your storage needs.

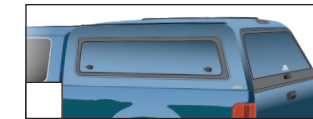

Universal Mounting Tracks

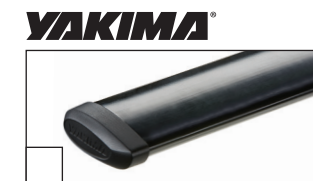

Yakima® CoreBar Roof Rack (Steel)



Add Popular Option: Load Stops
Yakima® JetStream Roof Rack (Aluminum)



KargoMaster Ladder Rack

PRIME DESIGN

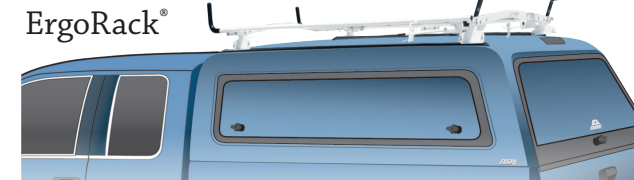

Double Clamping Double Rotational Driver Side Clamp and Passenger Side Rotational
 Optional Step Ladder Adaptor
Only available for Prime Design models on 8 foot beds.

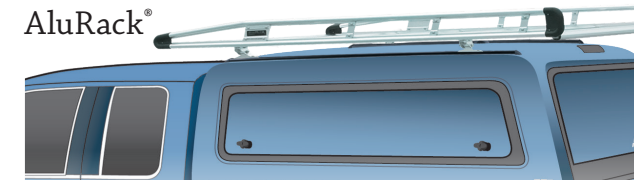

80" AluRack® Aluminum Rack System 98" AluRack® Aluminum Rack System 120" AluRack® Aluminum Rack System



Driver Passenger



Easy-Loading Roller System
Allows ergonomic loading and unloading of ladders, reducing stress and injuries. One person can easily load the ladders without damaging the vehicle.

8 CHOOSE A RIVAL LED LIGHTING OPTION

A. Choose your preference of our interior lighting options, including our encased rope lights.

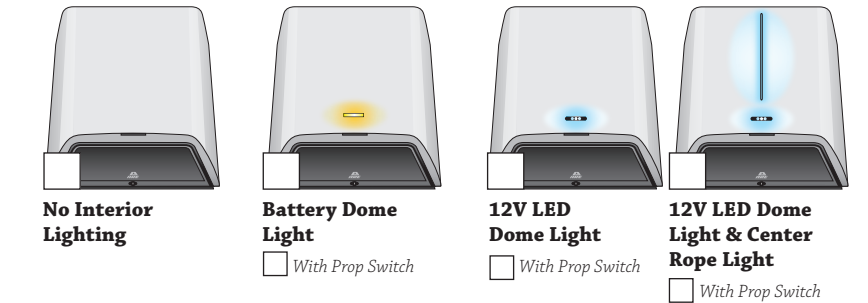

No Interior Lighting Battery Dome Light 12V LED Dome Light 12V LED Dome Light & Center Rope Light
 With Prop Switch With Prop Switch With Prop Switch With Prop Switch

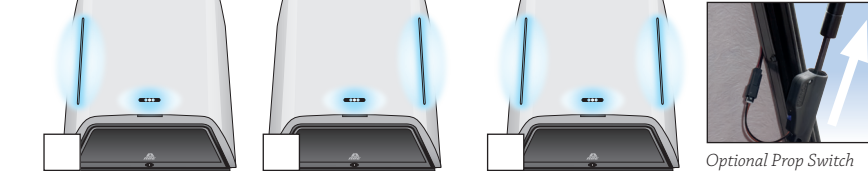

12V LED Dome Light, Driver Side Rope Light 12V LED Dome Light, Passenger Side Rope Light 12V LED Dome Light & Dual Rope Lights
 With Prop Switch With Prop Switch With Prop Switch

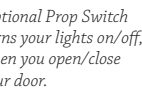

Optional Prop Switch turns your lights on/off, when you open/close your door.

TOOLMASTER WARRANTY

A.R.E. warrants to the original purchaser of ToolMaster™ truck caps that they are free from defects in structure, materials and workmanship for lifetime from the date of purchase from an authorized A.R.E. dealership. See the dealership for a copy of the full warranty statement.

TRUST THE LEADER

When you purchase our cap for your truck, you have 700 A.R.E. partners across North America ready to serve you. Major leasing companies rely on A.R.E. to provide caps and service to thousands of vehicles they own nationwide. You deserve the same peace of mind that they enjoy. See your local authorized A.R.E. dealer today to order the work cap that meets your needs.



FUSION

THE STYLE YOU WANT, THE ACCESSIBILITY YOU NEED.

Our newest cover, Fusion, provides you with a paint-to-match finish in a tri-fold cover. Fold the panels open for quick and easy full bed access or keep them closed for added security and styling.



PURPOSE FOCUSED, STYLE DRIVEN

Our belief has always been that you shouldn't have to sacrifice style for function. The Fusion combines tri-fold accessibility with paint-to-match finishing. Whether you need your truck to be your work companion all day or want a more stylish look when you are off the jobsite, the Fusion is your truck's perfect complement.

STANDARD FEATURES

- Tri-fold cover
- Paint-to-match panels
- Carpeted under panels
- Low-profile design
- Universal tailgate operation
- L-rail for quick and easy install
- Battery operated L.E.D. light





3DL™

UNPARALLELED ACCESS

Available for many of today's trucks. This tonneau cover exemplifies another innovative design from A.R.E. that makes loading and unloading easier for service workers. The 3DL™ turns the bed of the truck into an organized and readily accessible tool container that keeps dust and other elements out.

STANDARD FEATURES

- Two doors on each side
- The entire cover opens effortlessly from the rear of the truck using a hinge system at the front of the cover
- Roller rods for side doors allow for one-hand operation to provide easy access and improved seal
- Paint-to-match
- Design offers the driver excellent rear visibility from the cab of the truck
- Designed to keep products secure and out of sight
- Patented Palm Handle (black)

OPTIONAL FEATURES

- Remote keyless entry
- Rival LED strip lighting technology to illuminate the bed
- Diamond plate toolboxes

SPECIFICATIONS

- Adds over 4" above the truck bed rail of additional storage space



OPTIONAL DIAMOND PLATE TOOLBOX



RIVAL LED ROPE LIGHT OPTION ACTIVATED WHEN ANY DOOR OPENS



REMOTE KEYLESS ENTRY OPTION



LSII™

#1 FIBERGLASS TONNEAU COVER

The LSII™ offers truck specific styling, premium components and a unique lift assist system for user friendly opening and closing. With a sleek, clean appearance, a proven lock/latch system, a dry and out-of-sight storage area for tools and equipment and better rear visibility when backing up, this industry-leading tonneau cover is a best seller, and for good reason.

The LSII™ gives technicians and supervisors who live in gated communities with vehicle restrictions the ability to take their work trucks home.

STANDARD FEATURES

- Paint-to-match
- Slam latch system
- Lift assist arms
- Dark gray headliner
- Automotive grade lock system
- Continuous front hinge

POPULAR OPTIONS

- Rival by A.R.E. LED lighting
- Keyless entry



The LSII™ allows a pickup to get better gas mileage than it would with an open bed.



LOW PROFILE COMPOSITE CLAMP



HEIGHT ADJUSTERS PREVENT UNNECESSARY PAINT WEAR



MODULAR BASERAIL WITH WEATHER-RESISTANT SEAL



PULL STRAP



PALM HANDLE WITH SLAM LATCH SYSTEM

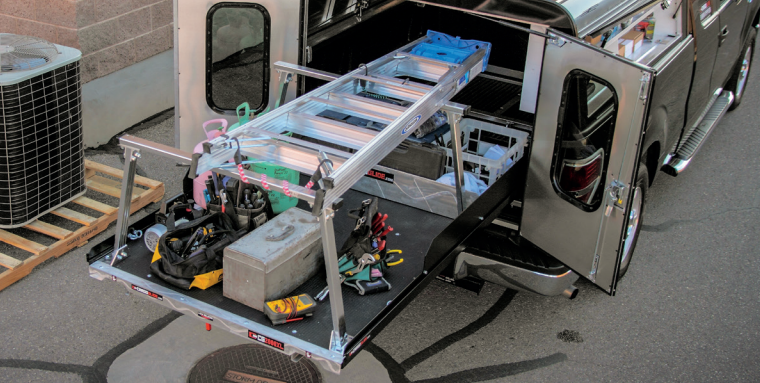

CHOOSE YOUR CARGOGLIDE®



CG1000
1000 lbs. capacity

75% of the cargo tray length slides out on short bed trucks and 70% on long beds. Sturdy steel frame construction. Real plywood deck with a laminated surface for strength and durability. 6 bearings total, 2 full complement permanently sealed ball bearings, 2 side thrust and 2 powerful needle bearings provide dependable lasting support for the cargo you haul in your CargoGlide.

Industrial 4" high extruded 6061-T6 thick anodized aluminum side rails with a slot style infinitely adjustable tie down track around all 3 sides, and includes 4 adjustable marine-grade tie down eyebolts to make securing cargo easy and versatile.



CG1500XL
1500 lbs. capacity

100% of the cargo tray length slides out for total access to your cargo. Real plywood deck with a laminated surface for strength and durability. 36 bearings total, 4 full complement double row, 16 single row permanently full complement sealed ball bearings and 2 cam follower sealed needle bearings provide dependable lasting support for the cargo you haul in your CargoGlide. This slide also has 14 more sealed side thrust bearings that make it slide easier when used on uneven ground.

Powder coated industrial 4" high extruded 6061-T6 aluminum side rails with a slot style infinitely adjustable tie down track around all 3 sides, and includes 4 adjustable marine-grade tie down eyebolts to make securing cargo easy and versatile. 8" high side extensions on the first 4' of the slide at the cab end helps contain more cargo.

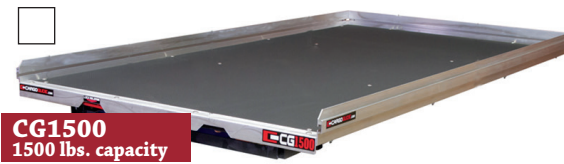

CG1500
1500 lbs. capacity

75% of the cargo tray length slides out on short bed trucks and 70% on long beds. Sturdy steel frame construction. Real plywood deck with a laminated surface for strength and durability. 8 bearings total, 6 full complement permanently sealed ball bearings and 2 side thrust bearings provide dependable lasting support for the cargo you haul in your CargoGlide.

Industrial 4" high extruded 6061-T6 thick anodized aluminum side rails with a slot style infinitely adjustable tie down track around all 3 sides, and includes 4 adjustable marine-grade tie down eyebolts to make securing cargo easy and versatile.



CG2200XL
2200 lbs. capacity

100% of the cargo tray length slides out for total access to your cargo. Real plywood deck with a laminated surface for strength and durability. 22 bearings total, 4 full complement double row, 16 single row permanently sealed ball bearings and 2 cam follower sealed needle bearings provide dependable lasting support for the cargo you haul in your CargoGlide.

Powder coated industrial 4" high extruded 6061-T6 aluminum side rails with a slot style infinitely adjustable tie down track around all 3 sides, and includes 4 adjustable marine-grade tie down eyebolts to make securing cargo easy and versatile. 8" high side extensions on the first 4' of the slide at the cab end, helps contain more cargo.



CARGOGLIDE® CARGO MANAGEMENT SOLUTIONS

The Easiest Way to Load and Unload

Say goodbye to the aggravation of a normal truck bed. With a CargoGlide® bed slide, you can stop crawling in the back of your truck or van every time you need to reach your gear. So stop scuffing your knees and breaking your back! Install a CargoGlide® in your truck and get your gear and materials out where you need them!

CargoGlide offers models that hold 1,000 lbs., 1,500 lbs. or even 2,200 lbs. Their full extension models slide out of the bed 100%, so you can eliminate the risk of injury for you or your employees.

Combined with an A.R.E. Truck Cap or Cover, the CargoGlide allows you to get maximum use out of your truck bed!



TRUCKVAULT® 2-DRAWER BED STORAGE SYSTEM



- Comes standard with two drawers, and folding t-handle lock
- No-drill turn buckle installation
- 5/8" medium density overlay (MDO) top surface will support up to 2,000 lbs. on top of TruckVault®
- Exterior finish: dark gray polypropylene, matches A.R.E. cap or cover carpeted interior option
- Interior finish: drop-in ¼" rubber mat
- Limited lifetime warranty – see your local retailer or www.truckvault.com for complete warranty information
- Approximate width: 39–48" based on bed width
- Approximate length: 46–94"+ based on bed length
- Approximate height: 10.5–12.5" based on truck model
- Standard drawer depth: 8"
- Each drawer holds up to 250 lbs.

STANDARD ACCESSORIES



Folding T-handle lock



No-drill turn buckle installation



Drop-in rubber mat drawer interior

ADDITIONAL ACCESSORIES



Drawer dividers (front to back and side to side)

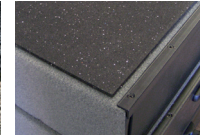

Top rubber mat



LED light (battery)



Tie down rails with cargo rings

SAFETY LIGHTING



STROBE

LUMENS: 300 AMBER
LUMENS: 700 WHITE
Remote or switch controlled

BEACON

LUMENS: 1700
Permanent or
Magnetic Mount



LUMALARM

DECIBELS: 97
LUMENS: 200 AMBER

WORK LIGHTS



ROUND
LUMENS: 1400



LED HYBRID
LUMENS: 2500

CUBE & FLUSH MOUNT LIGHTS



CUBE
LUMENS: 1080
Spot or Flood



FLUSH MOUNT
LUMENS: 1080
Spot or Flood



Rival by A.R.E. is a full LED lighting product line featuring factory-installed options on an A.R.E. product, as well as individually offered lighting to allow you to customize your fleet vehicles.

To learn more about Rival visit www.4are.com/product/rival.



Outfit for Work[®]

WWW.4ARE.COM / 1.800.649.4ARE

COMMERCIAL PRODUCTS



P.O. Box 1100, Massillon, Ohio 44648
 www.4are.com / 1.800.649.4ARE
 contact@4are.com
 www.facebook.com/aretruckcaps
 @areaccessories
 © A.R.E. Accessories, LLC., 2020



A.R.E. AUTHORIZED DEALER

ATTN: STATE OF CALIFORNIA CONSUMERS
 ⚠️ **WARNING:** Cancer and Reproductive Harm - www.P65Warnings.ca.gov.

Products in this brochure are subject to California Prop 65.